

Procesare fonologică

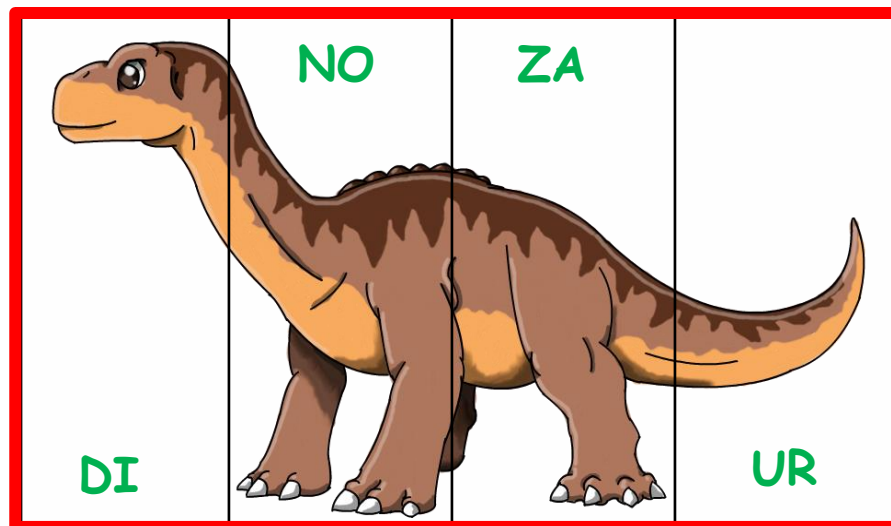

PI

RAT

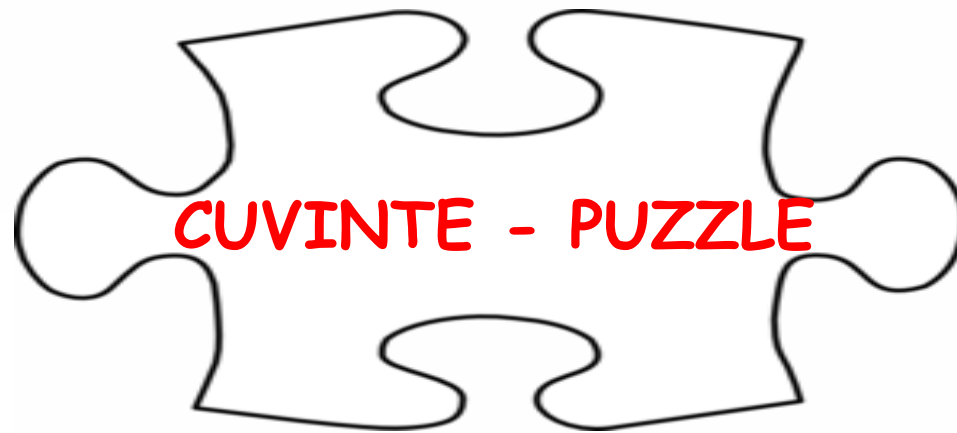

RO

BOT

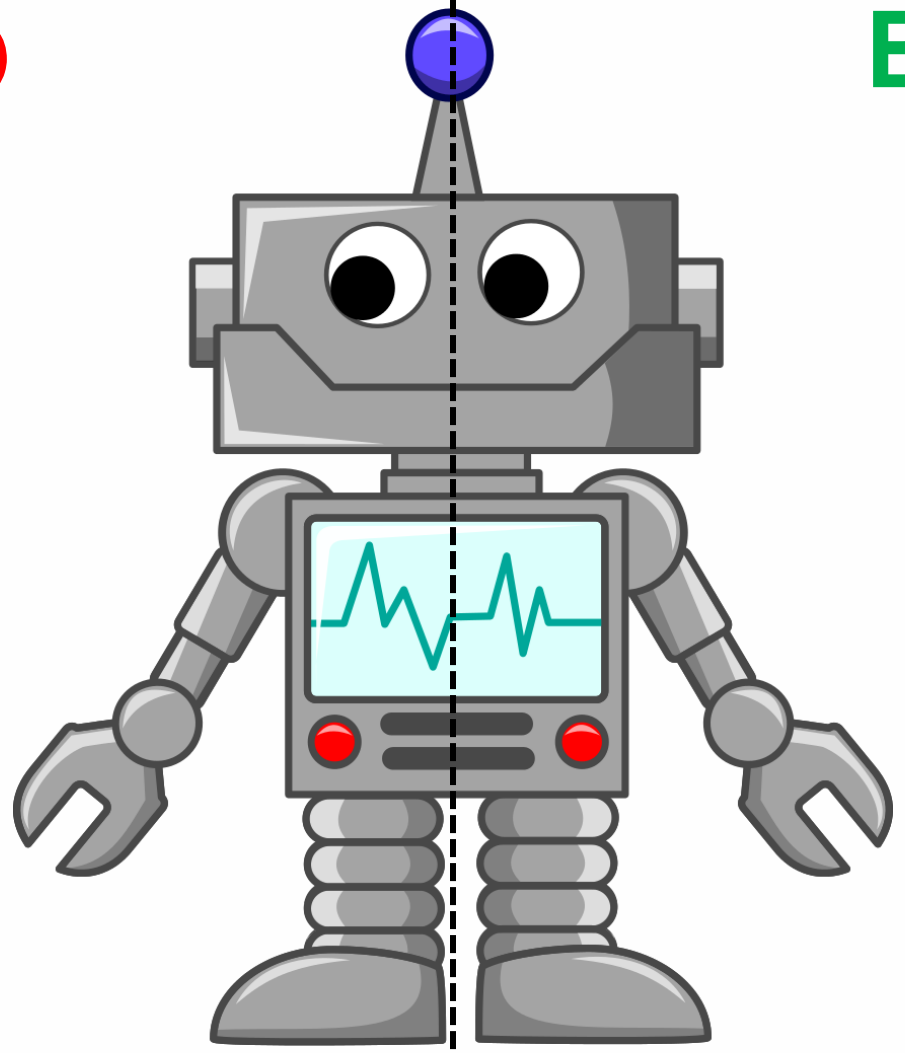

MIN

GE

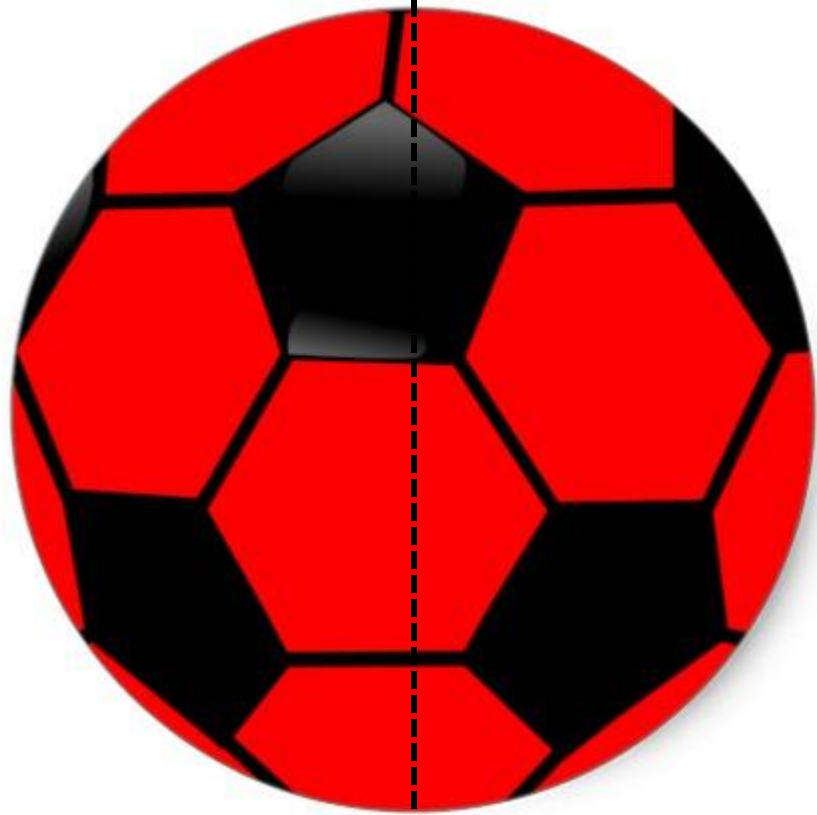

PUȘ

CĂ

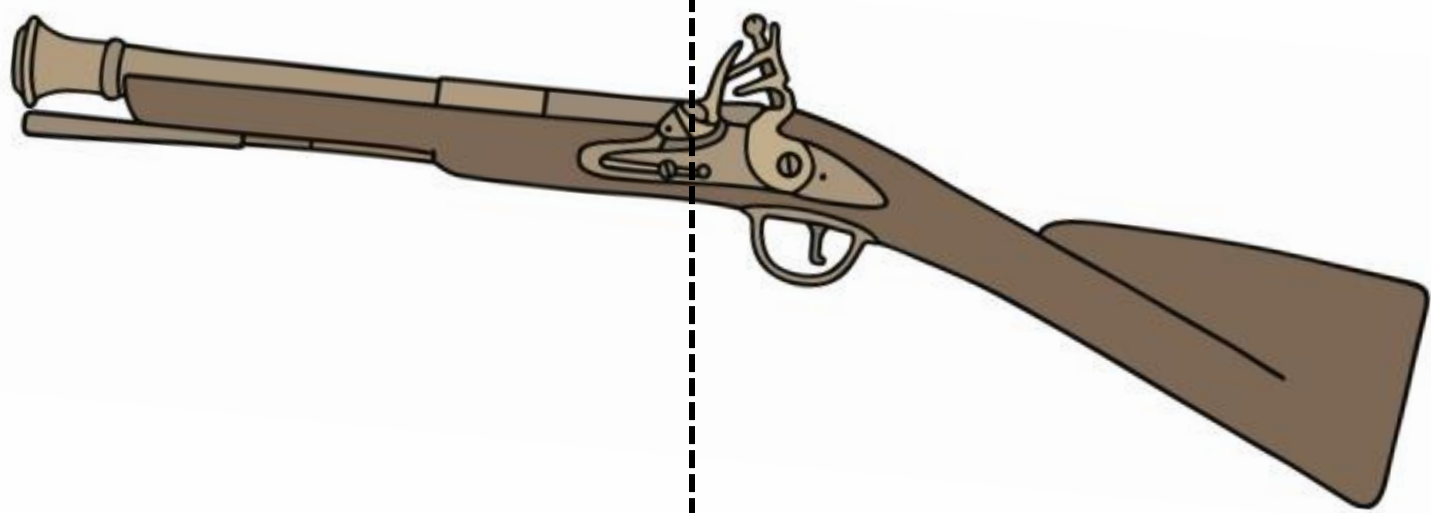

RA

CHE

TĂ

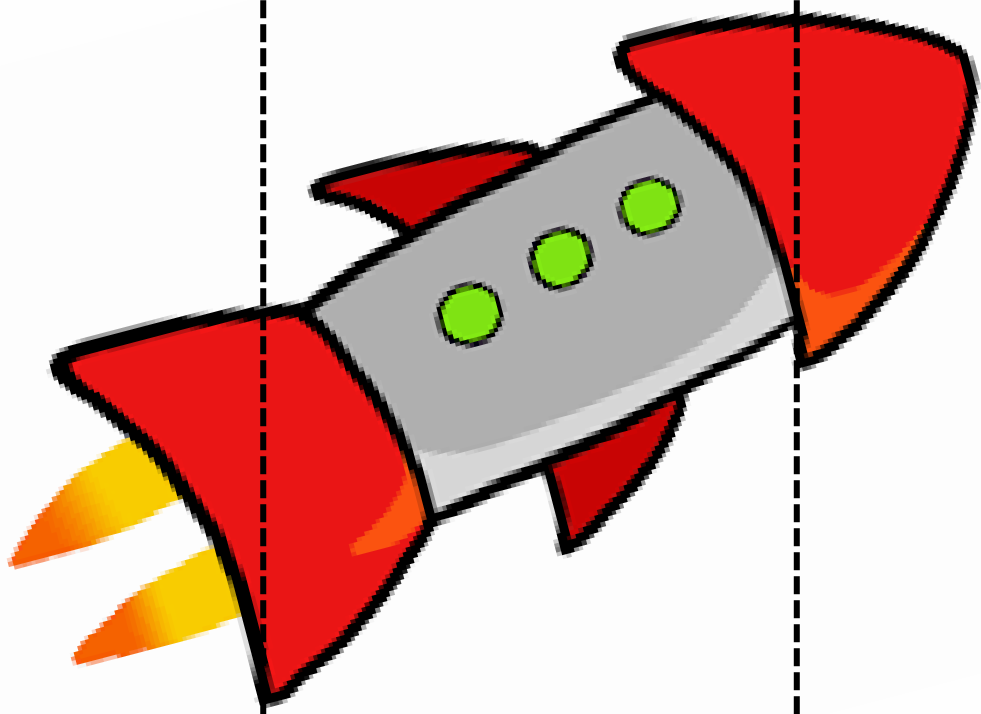

CA

MI

ON

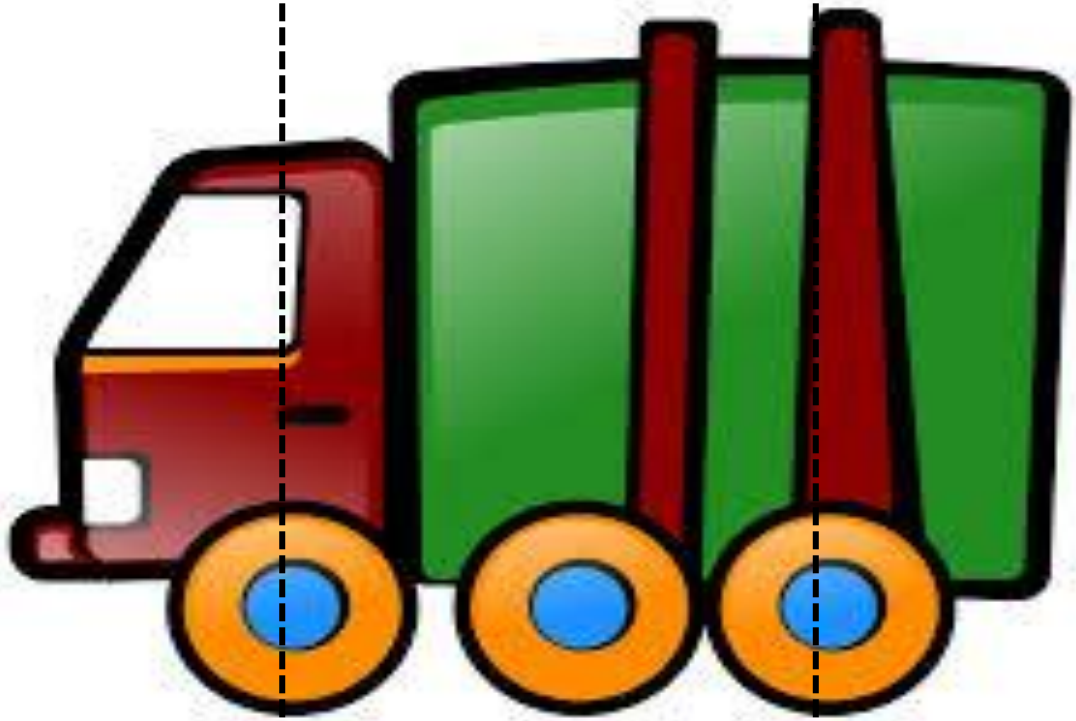

SA

BI

E

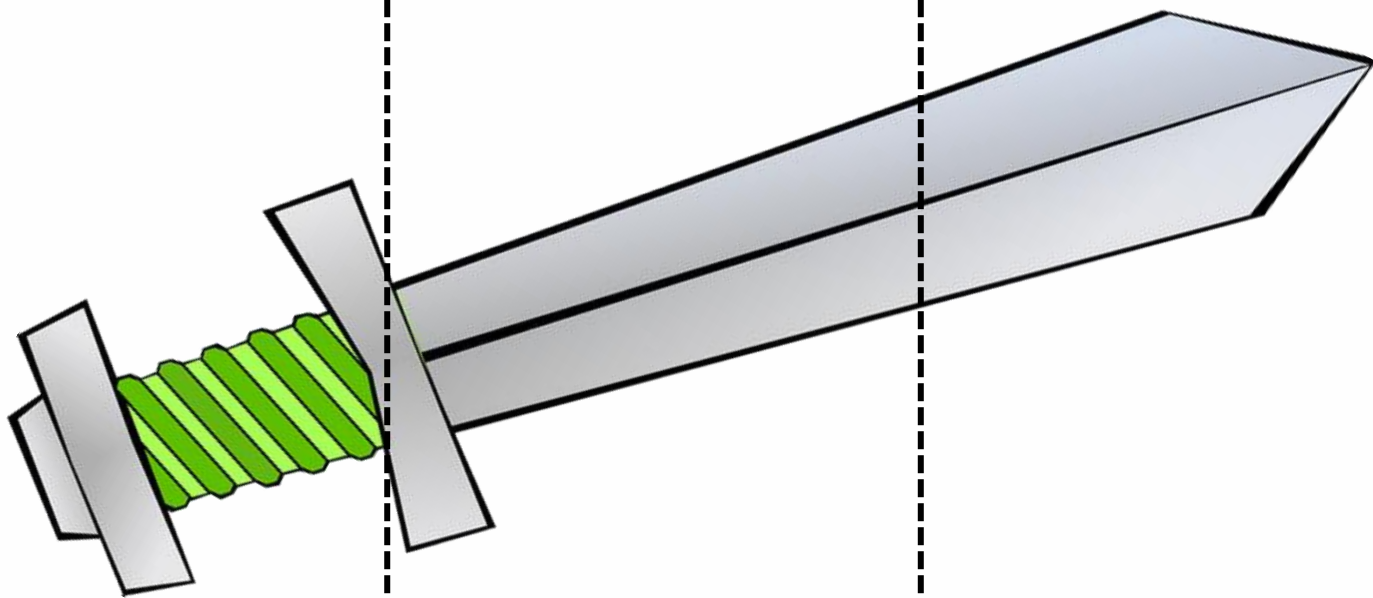

MA

ȘI

NĂ

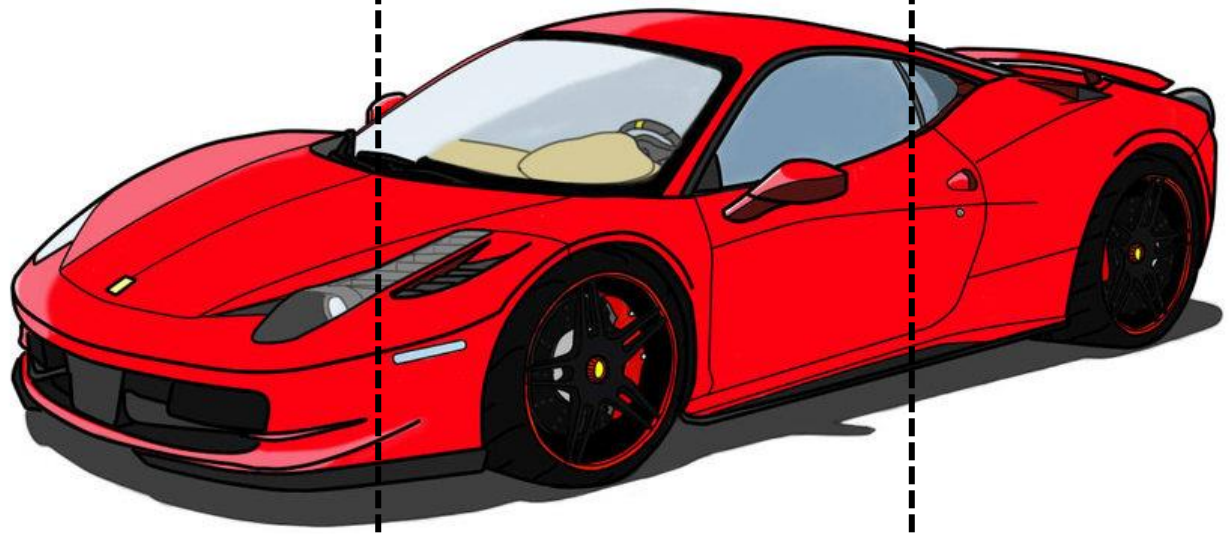

CO

RA

BI

E



BI

CI

CLE

TĂ

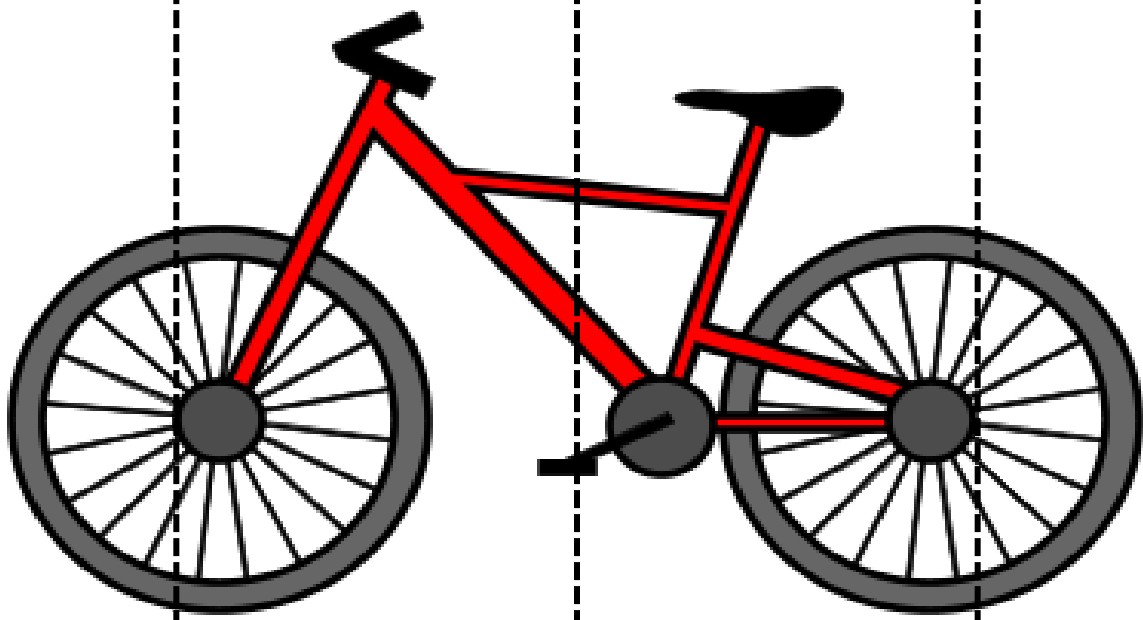

DI

NO

ZA

UR

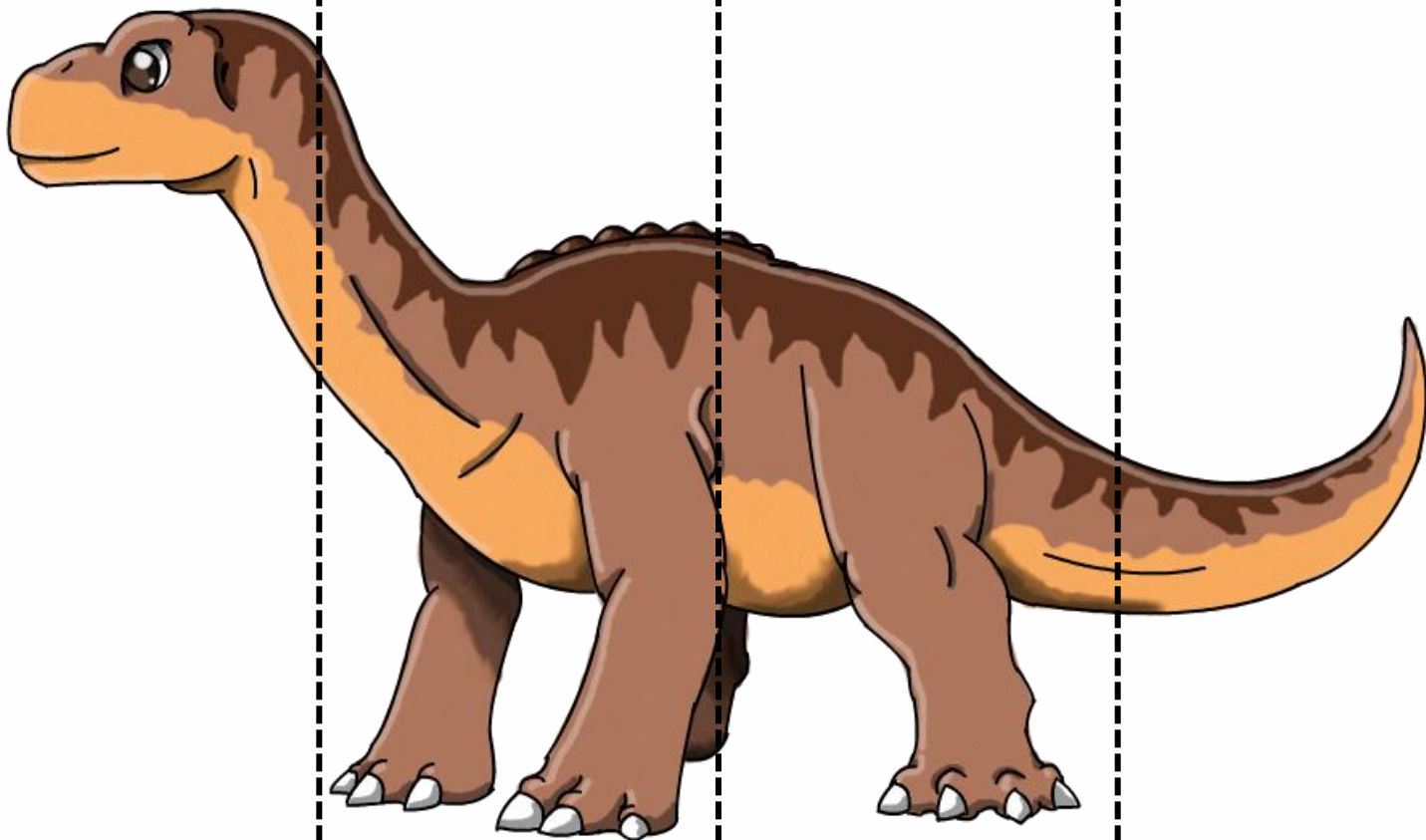

CAL

CU

LA

TOR

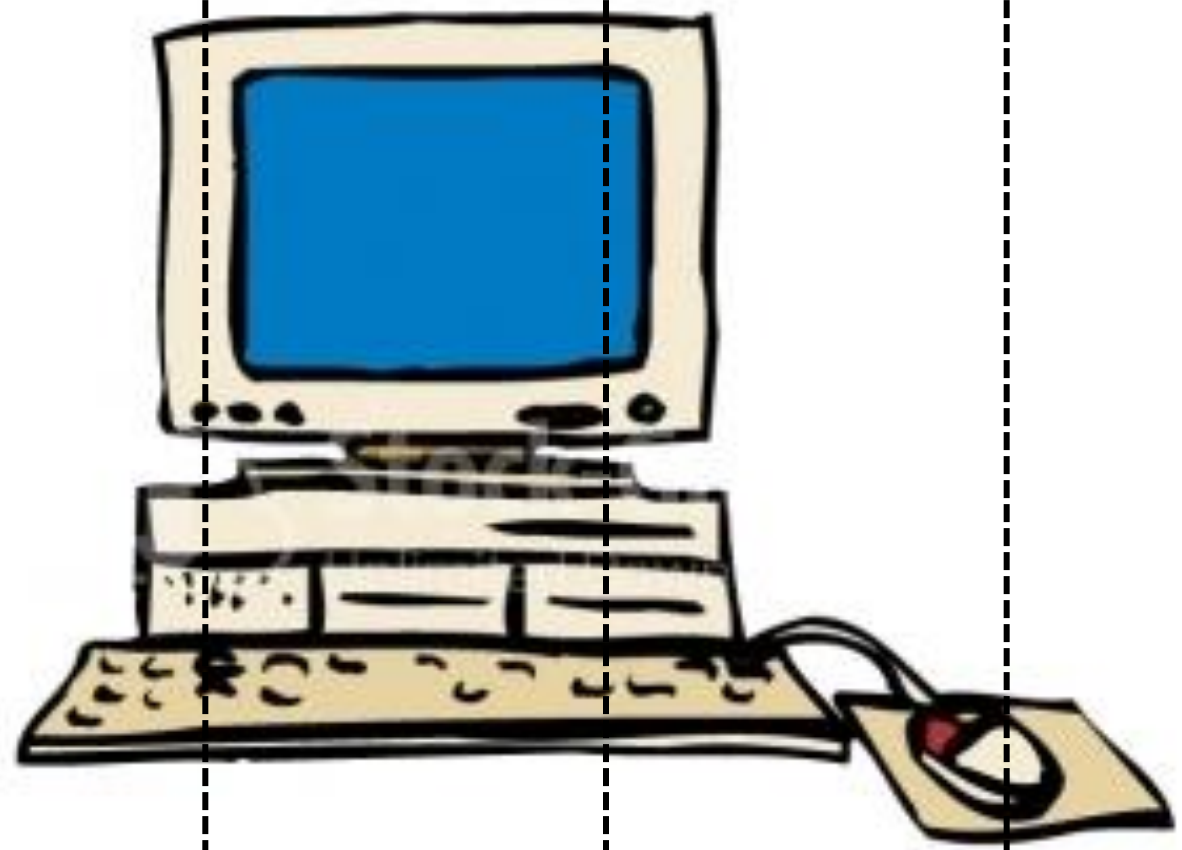

PO

NEI

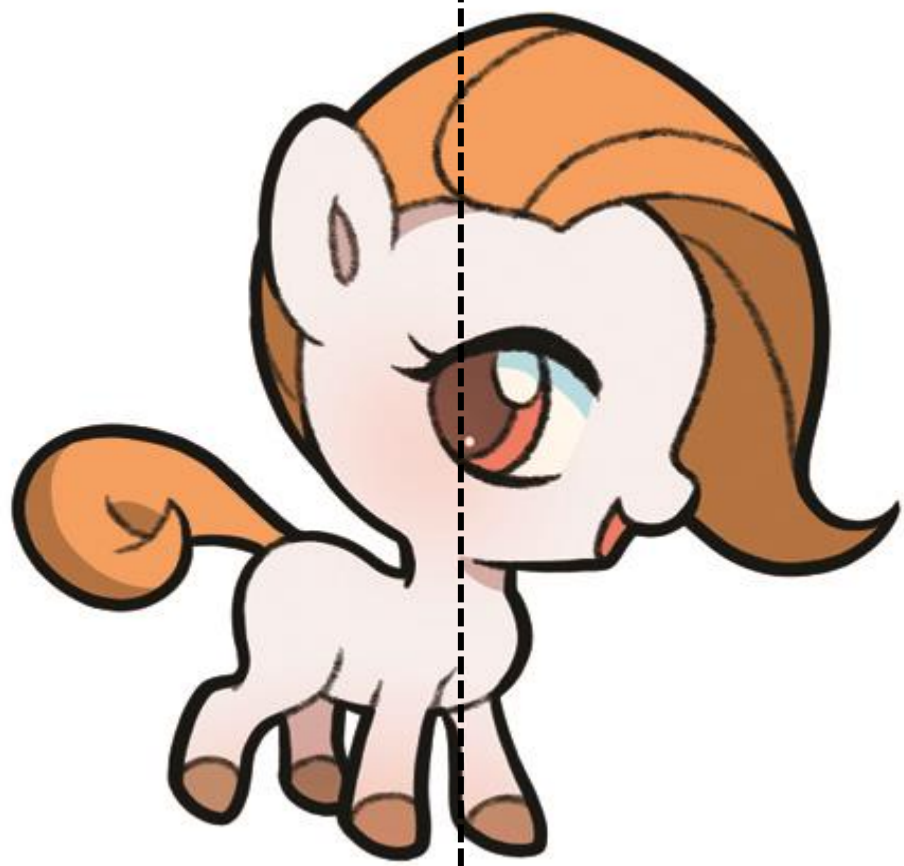

RO

LE



LAP

TOP



PĂ

PU

ȘĂ

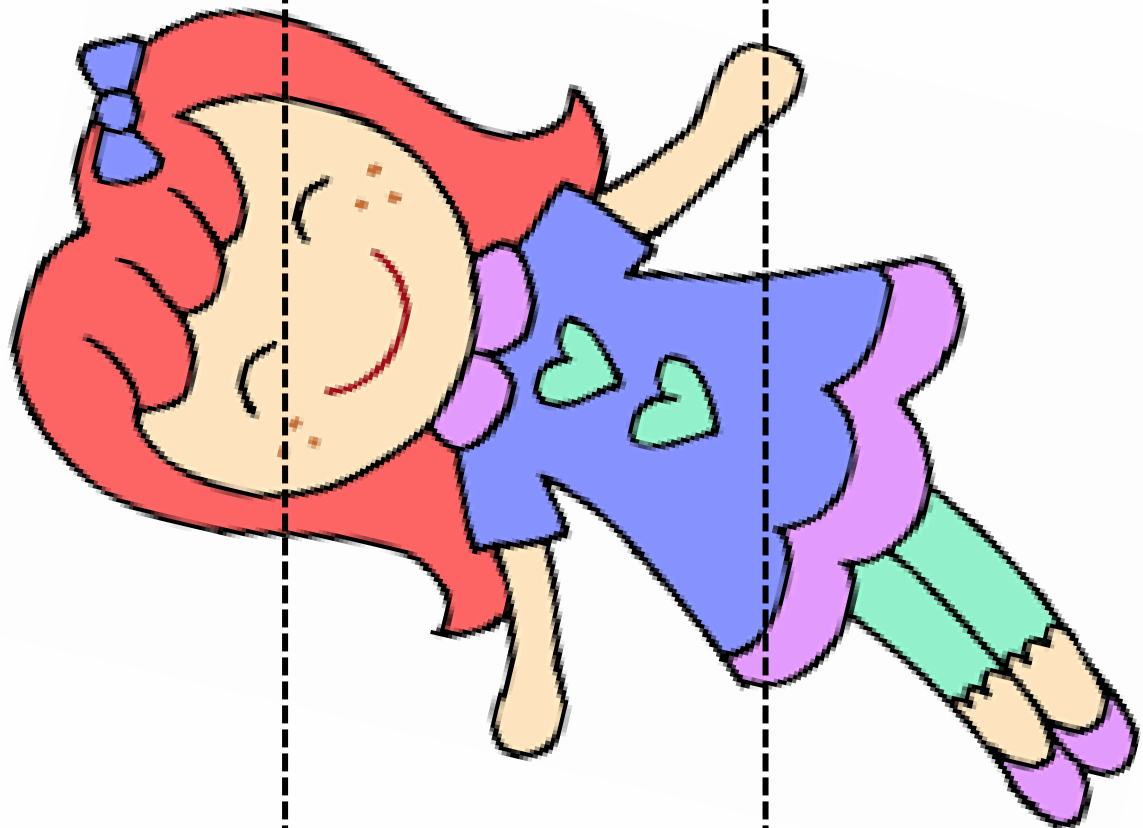

SI

RE

NĂ

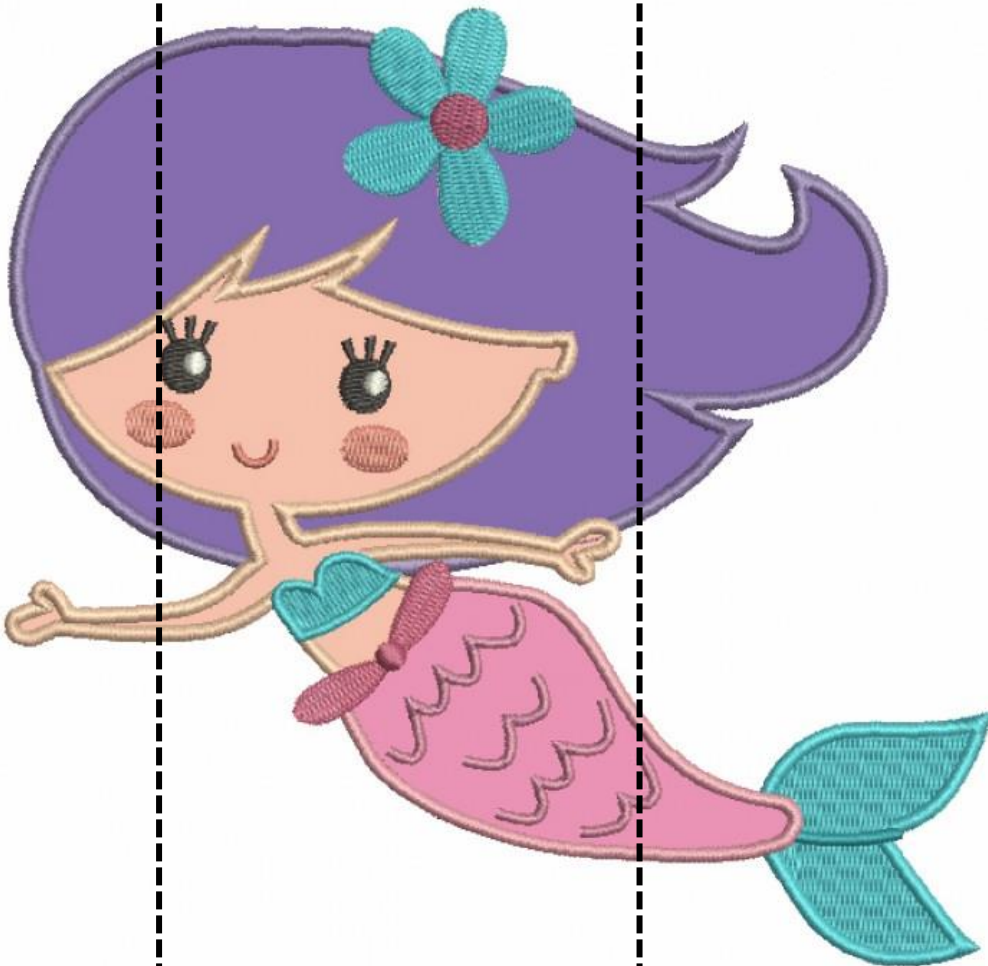

BA

LAN

SOAR

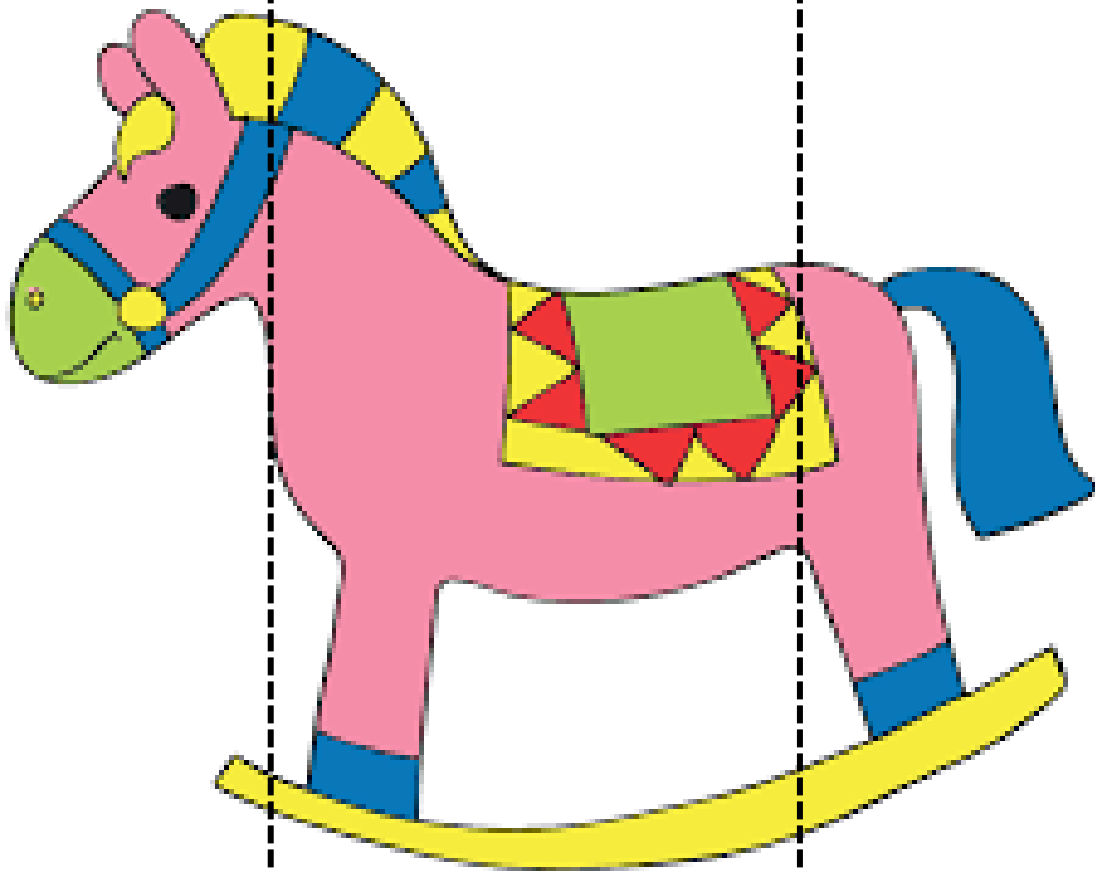

TE

LE

FON

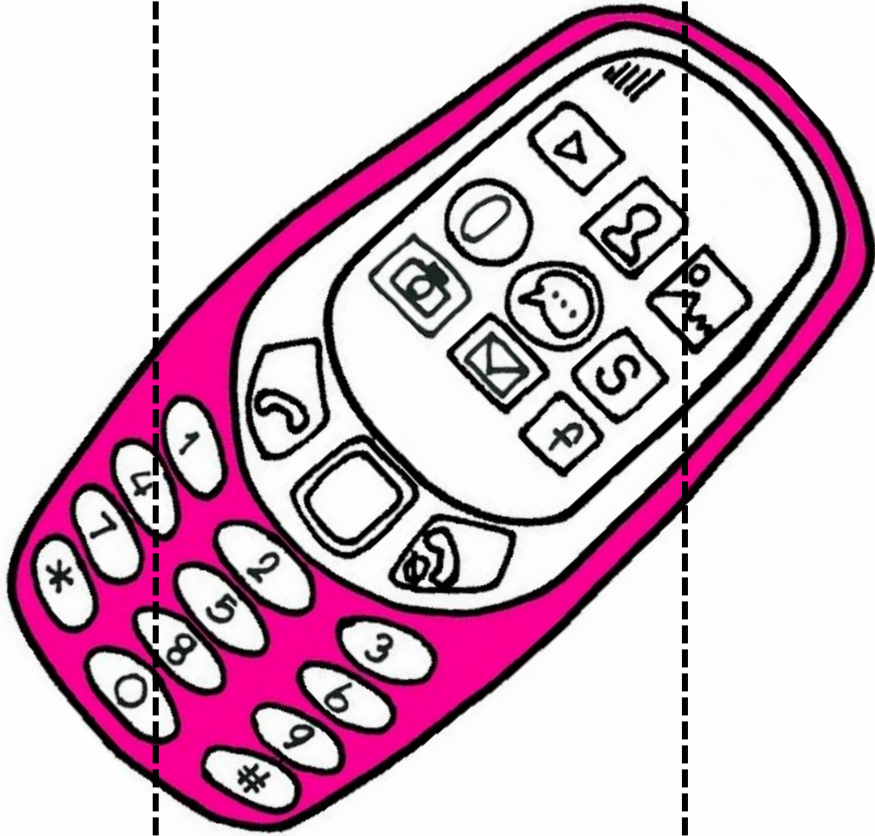

CĂ

RU

CIOR



UR

SU

LEȚ

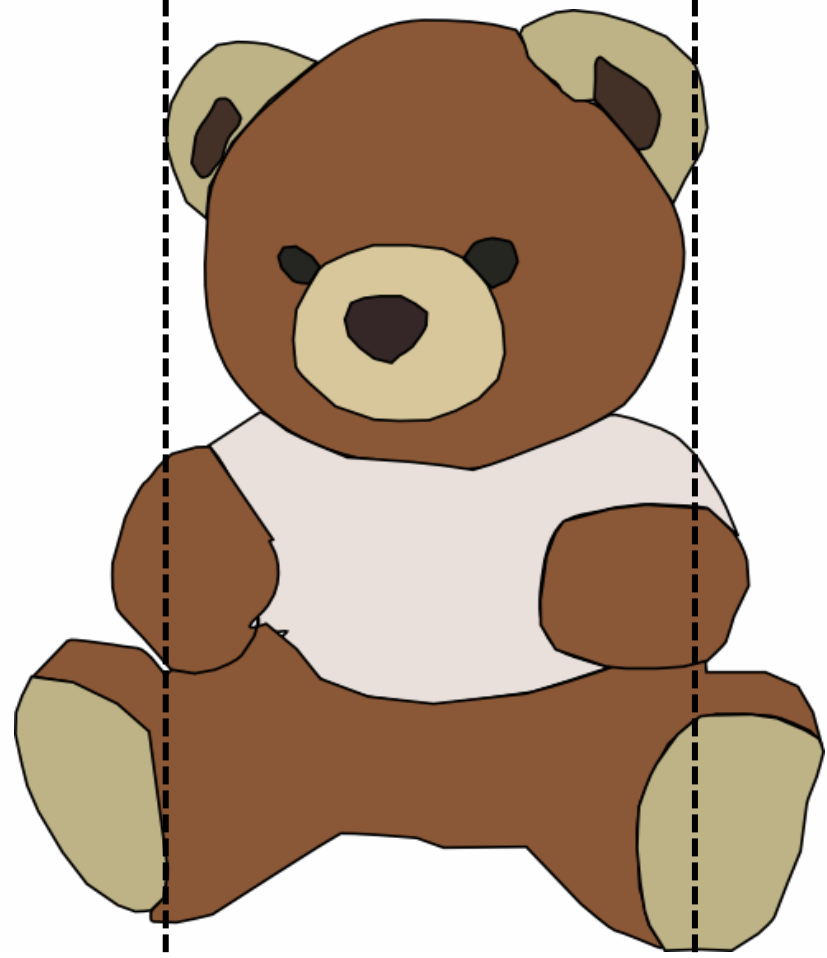

PO

ȘE

TĂ

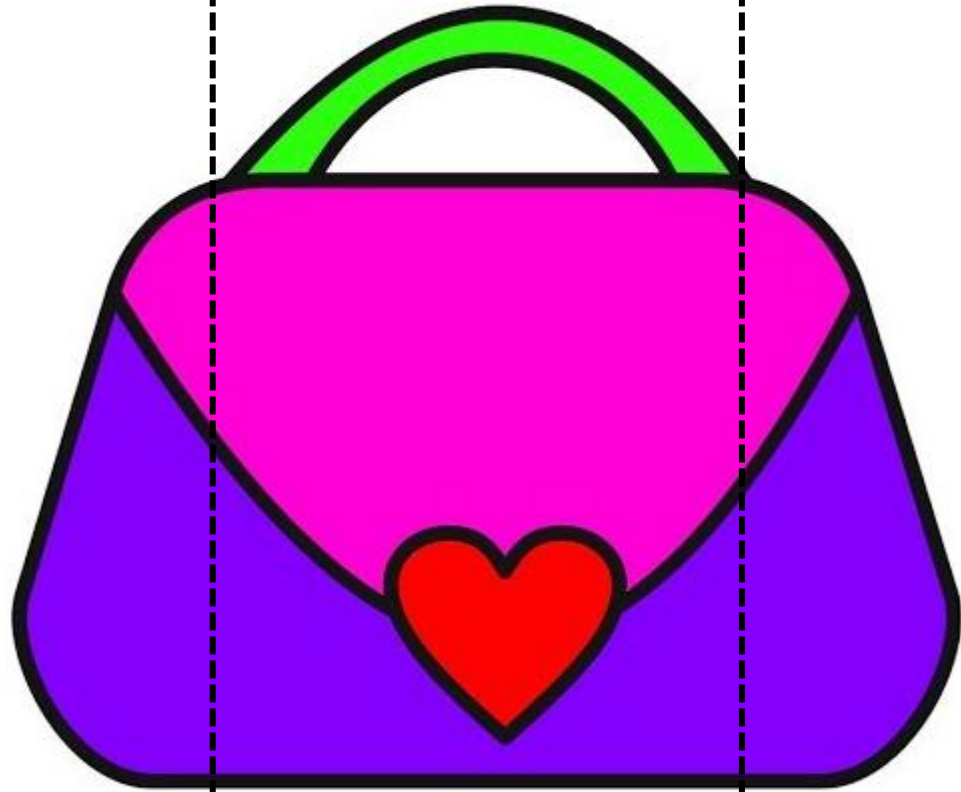

TRO

TI

NE

TĂ

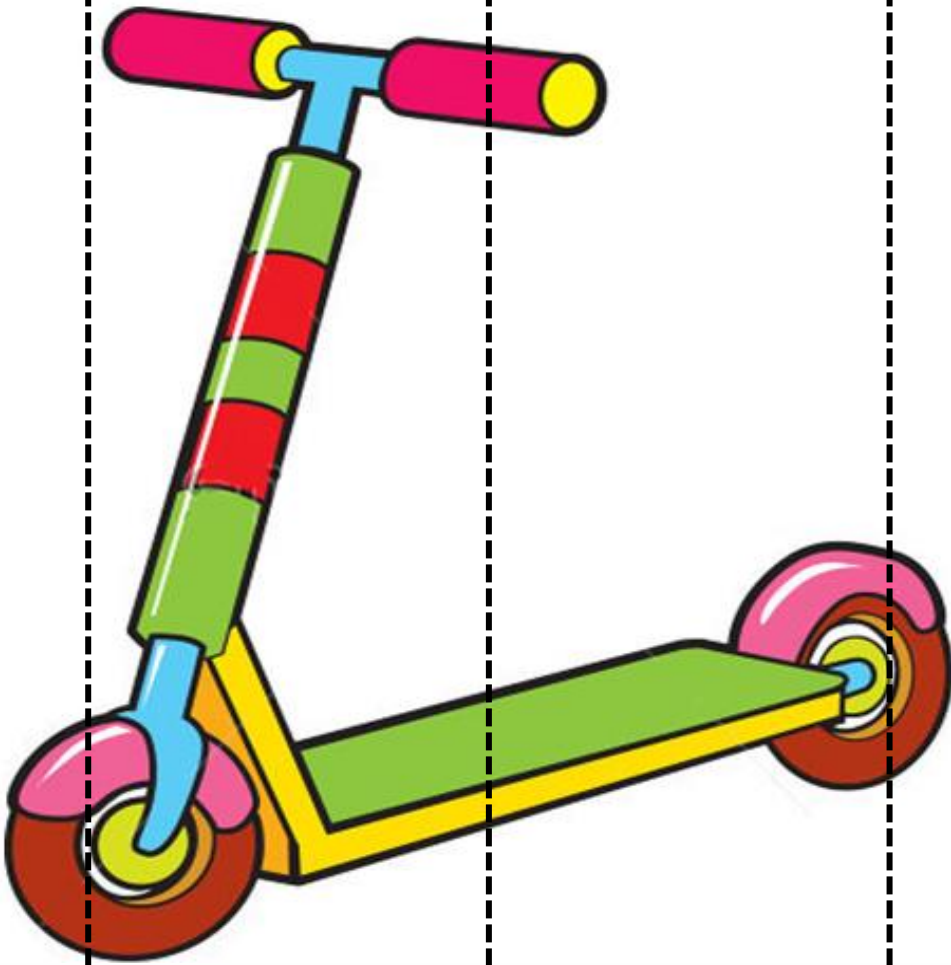

BI

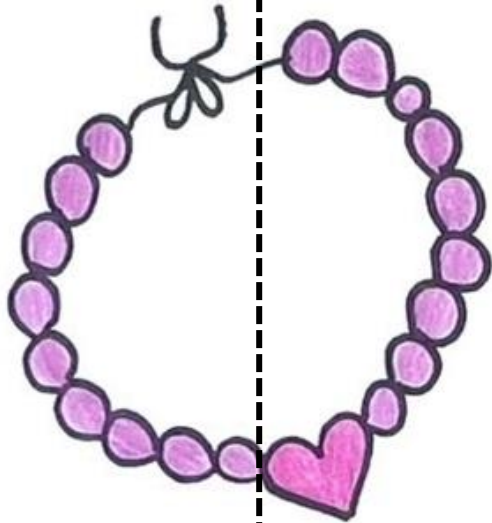

JU



TE



RII

